

Series Drop Box

A-180D S1

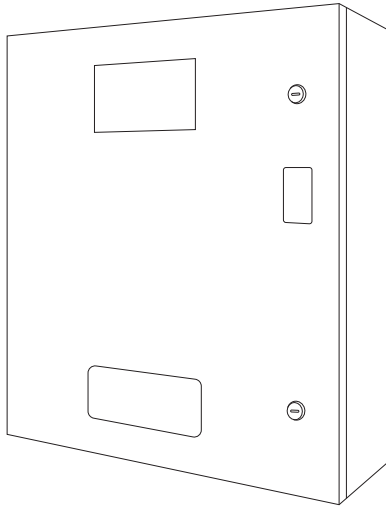

Product Manual

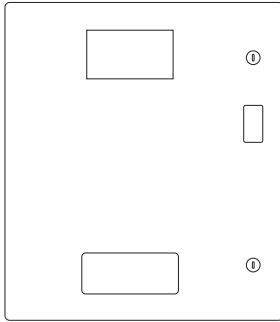

A-180D Key Cabinet X 1

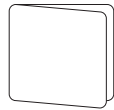

Product Manual X 1

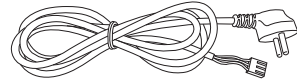

Power Cable X 1

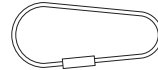

KeyTag X 20

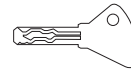

Mechanical Key X 4

Technical Parameters

Product Name	Series Drop Box
Model	A-180D S1
Dimensions (L*W*H)	485mm x 225mm x 553mm
Weight	27.3 kg net
Material	Steel
Thickness of steel	1.5mm
KeySlot	15
Operating System	Android
Display	7" Touchscreen
Power Supply	12V 5A

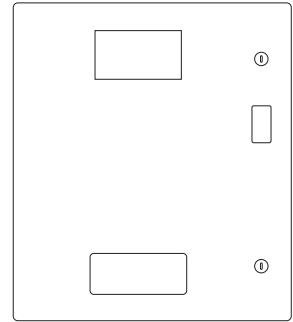

485mm

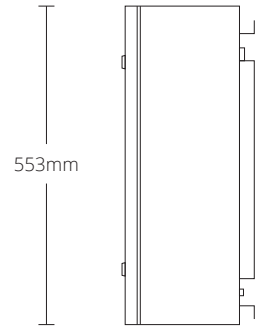

553mm

225mm

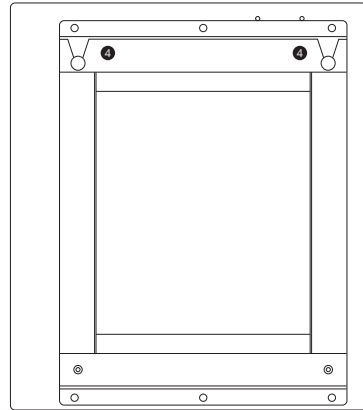
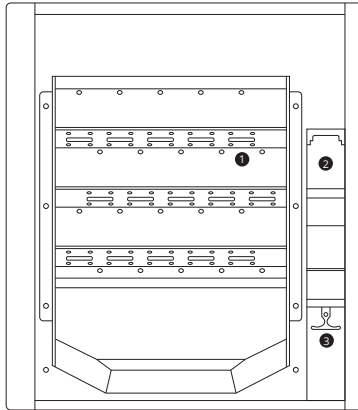

- ① KeySlot
- ② Key Return Entrance
- ③ Key Return Box
- ④ Support Frame

Login Interface

- 1 Click the Touchscreen.
- 2 Input the Administrator Password.
- 3 Click " ✓ ".

Please contact the salesman for ID and Password.

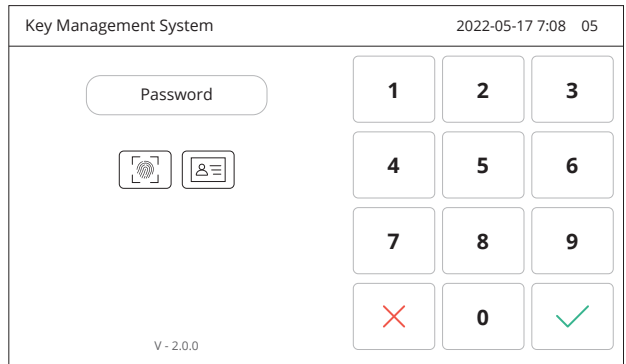

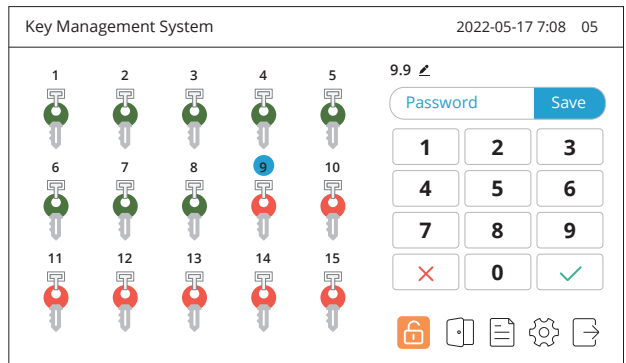
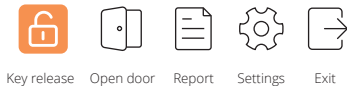

Main Interface

The main interface shows the status of all keys, key settings area and menu bar.



Register key

- 1 Click "  " to open the door.
- 2 Insert keys.
- 3 Close the door.
- 4 Click the icon to select a key.
- 5 Click "  " to edit the key name.
- 6 Enter the password, click "Save".
- 6 Repeat steps 4-6 to set more keys.

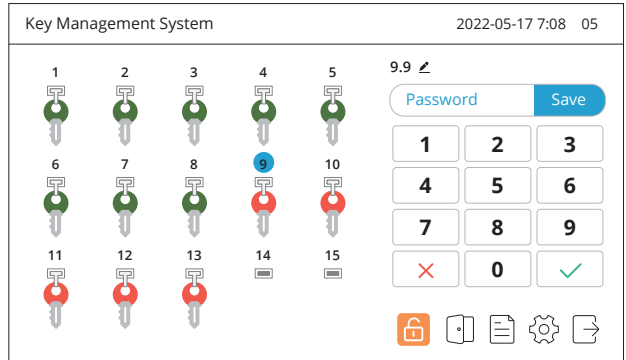

Key Status



The key with password is present.



The key without password is present.



The key is absent.

Take keys

- 1 Input the key password.
- 2 Click " ✓ ".
- 3 The key is automatically dropped.

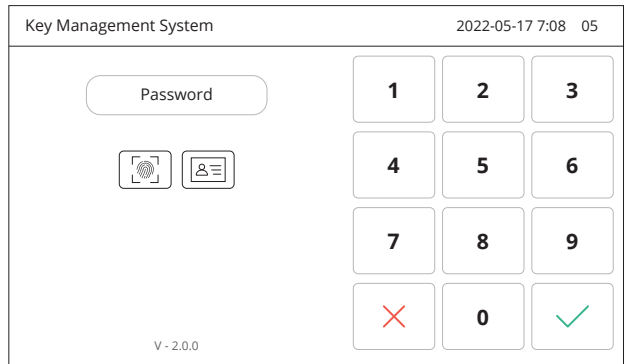

Return keys

Returning the key is very simple, just throw the key into the key return box.

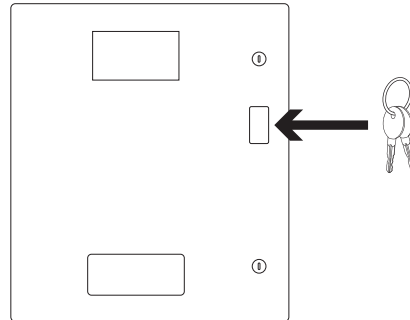

Exit

Set the time for automatic exit, the system will automatically exit when there is no operation.

Volume

Adjust volume by swiping.

Language

5 languages available: Chinese, English, German, French, Italian.

Admin password

Set the time for automatic exit, the system will automatically exit when there is no operation.

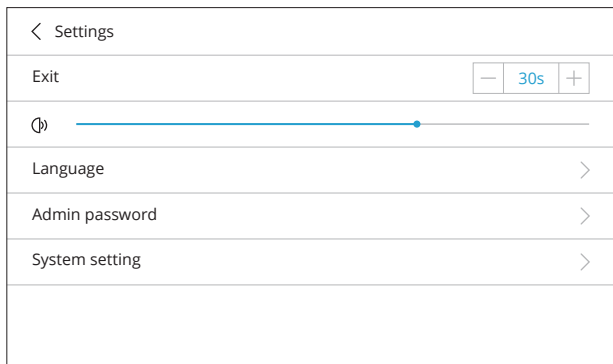

The screenshot shows the 'Settings' application. At the top, there is a back arrow and the text '< Settings'. Below this, there are several settings items: 'Exit' with a value of '30s' and minus/plus buttons; a volume slider with a blue indicator; 'Language' with a right-pointing arrow; 'Admin password' with a right-pointing arrow; and 'System setting' with a right-pointing arrow.

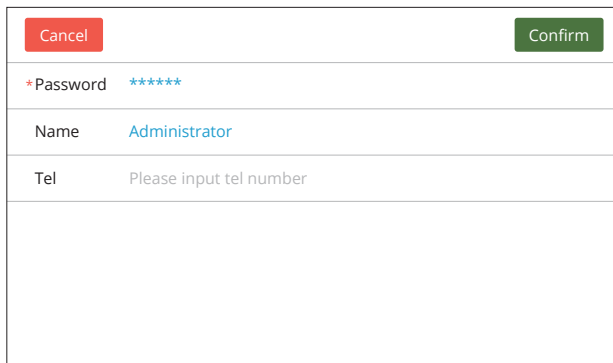

The screenshot shows the 'Admin password' setup screen. At the top, there are two buttons: a red 'Cancel' button on the left and a green 'Confirm' button on the right. Below the buttons, there are three input fields: '*Password' with a masked value of '*****'; 'Name' with the value 'Administrator'; and 'Tel' with the placeholder text 'Please input tel number'.

View Report

Click "  " on the main interface to view Report.

Report			Export
Key	<input type="radio"/> Abnormal	Start Time	End Time
		17-04-2022 11:34	17-05-2022 11:35
● 2		17-05-2022 11:34:13	Returned
● 7		17-05-2022 11:33:27	Returned
● 5		17-05-2022 11:33:22	Returned
● 7		17-05-2022 11:26:12	Taken
● 9		17-05-2022 11:25:17	Taken

Export Report

- 1 Insert USB external storage device.
- 2 Click "Export", select "pages".
- 3 Click "Export to external storage device".

Select Page

To

Special Announcement

Please refer to the actual product, the instructions are for reference only.

The manual and program will be updated in real time according to the product, and there will be no further notice if there is an upgrade.

If you do not follow the instructions in the manual, the user shall bear any losses caused thereby.

The final interpretation of this manual belongs to Landwell Europe GmbH

© Copyright Landwell 2023

LANDWELL